

MCA14

Control Carbon
Potentiometers MCA

MCE14

Control Cermet
Potentiometers MCE

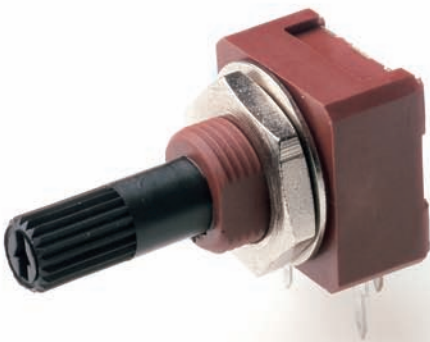

CARBON – MCA14

14mm carbon potentiometers with plastic enclosure and shaft.

Through-hole and SMD configurations are available. Terminals and collector are normally manufactured in tinned brass, although versions with steel terminals are also available under request. Terminals for through-hole models can be provided straight or crimped, which helps hold the component to the PCB during soldering.

Ingress Protection rating type IP 54 (high level of protection against dust and also against water splashing), according to IEC 60529. Plastic materials can be self-extinguishable according to UL 94 V-0 under request.

Tapers can be linear, log and antilog; special tapers can also be studied.

Potentiometers can be manufactured in a wide range of possibilities regarding:

- Resistance value.
- Tolerance.
- Tapers / variation laws.
- Pitch.
- Positioning of the wiper (standard is at 50% rotation).
- Housing and rotor color.
- Mechanical life.
- Click effect (up to 38 detents available).
- Self-extinguishable plastic parts according to UL 94 V-0.

Applications

14mm potentiometers are mainly used in control applications, in different markets:

- Electronic household appliances, heating, ventilation and air conditioning (HVAC) equipment, thermostats.

CERMET – MCE14

14mm cermet potentiometers with plastic enclosure and shaft. Cermet potentiometers have better thermal stability, allow for higher thermal dissipation and withstand higher temperatures than carbon potentiometers.

Through-hole and SMD configurations are available. Terminals and collector are manufactured in tinned brass, although versions with steel terminals are also available under request. Terminals for through-hole models can be provided straight or crimped, which helps hold the component to the PCB during soldering.

Ingress Protection rating type IP 54 (high level of protection against dust and also against water splashing), according to IEC 60529. Plastic materials (housing and rotor) are self-extinguishable according to UL 94 V-0 for ACP's cermet potentiometers.

Tapers can be linear, log and antilog; special tapers can also be studied.

Potentiometers can be manufactured in a wide range of possibilities regarding:

- Resistance value.
- Tolerance.
- Tapers / variation laws.
- Pitch.
- Positioning of the wiper (the standard is at 50%).
- Housing and rotor color.
- Mechanical life.
- Click effect (up to 38 detents available).

Applications

14mm cermet potentiometers are used in applications where either the operating temperature is high, or where the applications requires product with excellent ohmic value stability:

- Electronic appliances: boilers, water heaters.
- Industrial electronics: multimeters, oscilloscopes, time relays, measurement and test equipment.

MCA14 MCE14 HOW TO ORDER

EXAMPLE: **MCA14NH2,5-10KA2020 SNP PI WT-14187-BA**

EXAMPLE: **MCE14NH2,5-10KA2020 SNP PI WT-14187-BA-V0**

Standard features								Extra features							Assembled accessory			
Series	Rotor	Model	Packg.	Ohm value	Taper	Tol.	Life	Track	Detents	Snap in	Housing	Rotor	Wiper	Lin.	Assembly	Ref #	Color	Flam.
1	2	3	4	5	6	7	8	9	10	11	12	13	14	15	16			
MCA14 MCE14	N	H2,5		- 10K	A	2020		SNP					PI		WT	-14187	-BA	

Standard configuration:	MCA14 Through-hole	MCE14 Through-hole
Dimensions:	14mm	
Protection:	IP 54 (dust-proof) On request: Self-extinguishable, to meet UL 94 V-0	
Substrate:	Carbon technology	Cermet
Color:	Blue housing + white rotor	Brown housing + white rotor
Packaging:	Bulk	
Wiper position:	at 50% ± 15°	
Terminals:	Straight, without crimping.	
Marking:	Resistive value marked on housing. Others on request.	

Customized products: A drawing is requested when ordering a customized product. Series, rotor, model and total resistive value are indicated before the code that includes all special specifications. Example: MCA14PH2,5-10K CODE C00111. Other features could be available on request, please, ask.

1 - Series

■ MCA14 ■ MCE14

2 - Rotors

N Z

3 - Model and pitch

H0	HC0	H2,5	H4	H5	HA5	HL5	V12,5
VA12,5	VL12,5	VR12,5	V15	VJ15	V17,5	VD7,5	VD11

4 - Packaging

Trough-hole

Bulk (blank)...⁽¹⁾

5 - Resistance value

100Ω	200Ω	220Ω	250Ω	470Ω	500Ω	1KΩ	2KΩ	...	500KΩ	1MΩ	2MΩ	2M2Ω	4M7Ω	5MΩ
100	200	220	250	470	500	1K	2K		500K	1M	2M	2M2	4M7	5M

6 - Resistance law / taper

Lin - Linear	A
Log - Logarithmic	B
Antilog - Antilogarithmic	C
- Special tapers have codes assigned:	CODE YXXXXX

7 - Tolerance

±20%	±30%	+50%,-30%	±10%	±5%
2020	3030	5030	1010	0505

8 - Operating Life (Cycles)

Standard (1.000 cycles) (leave blank)
Long life: LV + the number of cycles. ex: LV45 for 45.000 cycles. (others on request) LVXX: ex: LV45

9 - Cut Track - Open circuit.

Open circuit at beginning of track, fully CCW	PCI
Open circuit at end of track, fully CW	PCF

10 - Detents (DT)

One detent at the beginning	DTI
One detent at the end	DTF
X number of detents	XDT: 10DT

Special detents are available on request: If you also need to assign a voltage value to each detent, please inquire.

11 - Terminals

SNAP IN P	SNP
SNAP IN J	SNJ
Shorter tip of terminal, TPXX, where XX is tip length (under request)	TPXX, ex: TP25
Steel Terminals	SH

12 - Housing

Color: For colors other than standard: -See color chart below- CJ-color, ex., red: CJ-RO

13 - Rotor

Color: For colors other than standard: -See color chart below- RT-color; ex., blue: RT-AZ

* Self-extinguishable property, V0, for housing and rotor:

By default, carbon is non self-extinguishable, cermet is Self-extinguishable: (blank)
For carbon: self-extinguishable property can be added. V0 means housing and rotor are V0. If only the housing needs to be V0, then CJ-V0. CJ-V0, RT-V0
If only rotor: RT-V0

14 - Wiper

Wiper position (Standard: 50% ± 15°)	(leave blank)
Initial or CCW	PI
Final or CW	PF
Others: following clock positions; at 3 hours: P3H	PXH, ex: P3H
Wiper torque (Standard: <2.5Ncm, for detents: <3.5)	(leave blank)
Low torque, < 1.5Ncm	PGB

15 - Linearity

Not controlled	(leave blank)
Independent linearity controlled & below x%, for example, 3%: LN3%	LNx%; ex: LN3%
Absolute linearity controlled & below x%	LAX%

16 - Potentiometers with assembled accessories

Assembled from terminal side	WT
Accessory Reference	-XXXXX
See list of shafts and thumbwheels available	Example: 14187
Color of shaft or thumbwheel	-YY Example, white: BA
Non self-extinguishable. Self-extinguishable according to standard UL 94 (-V0 in box 17 modifies only the accessory, please, note.)	(leave blank) -V0

Color chart for rotor, housing and accessories

Black ⁽¹⁾	White	Neutral	Transp.	Red	Green	Yellow	Blue	Grey	Brown
NE	BA	IN	TA	RO	VE	AM	AZ	GS	MR

(1) black is not an option for housings.

All models shown here have shaft 14187, but other shafts can be chosen from the list below. The D dimension indicated on the drawings refers to the possible length of the shaft, to be chosen at "shafts" section. Potentiometers are sold separately from the nuts and washers.

H0

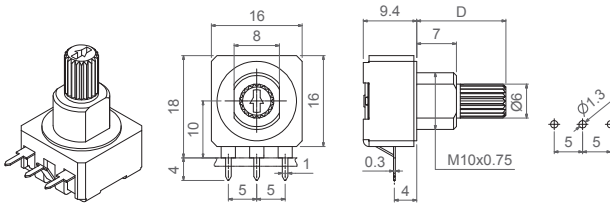

HC0

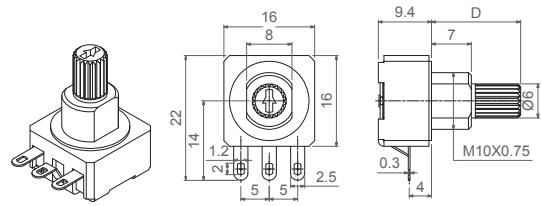

H2,5

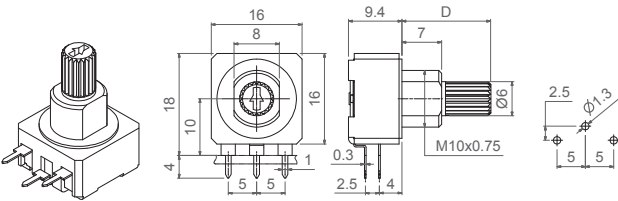

H4

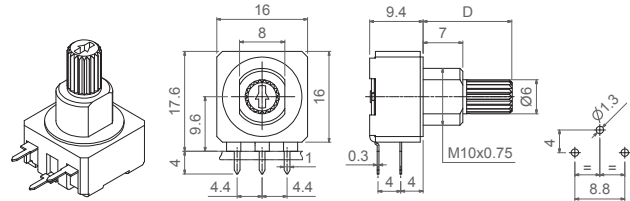

H5

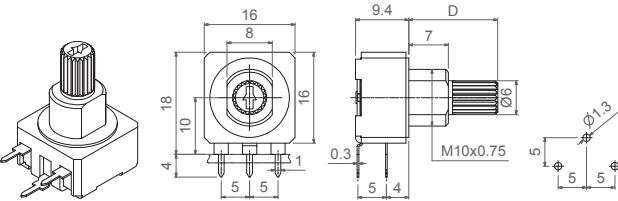

HA5

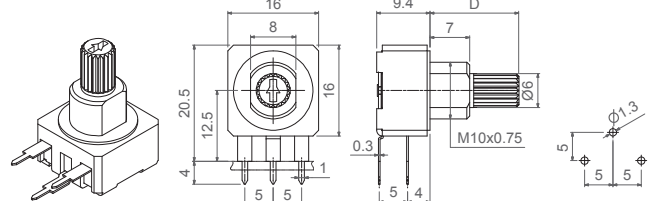

HL5

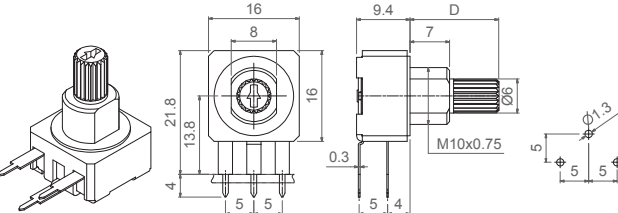

V12,5

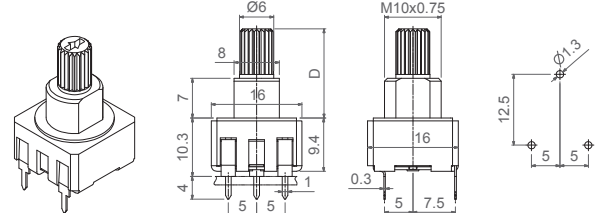

VA12,5

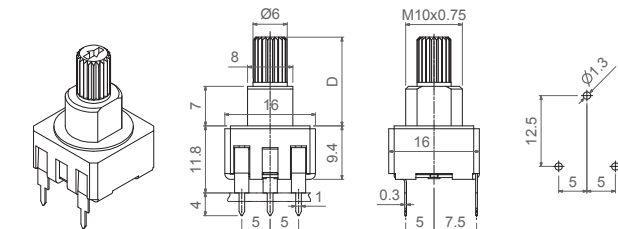

VL12,5

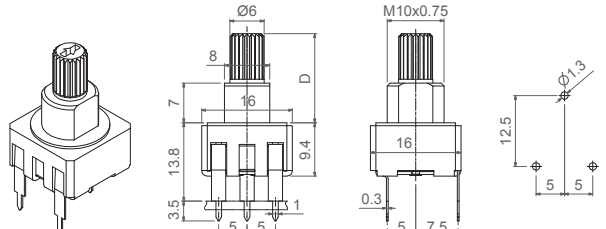

VR12,5

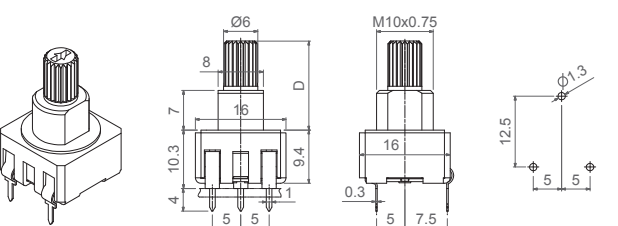

V15

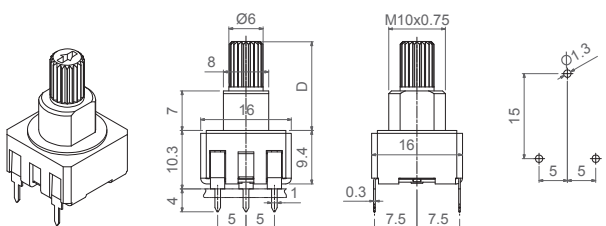

VJ15

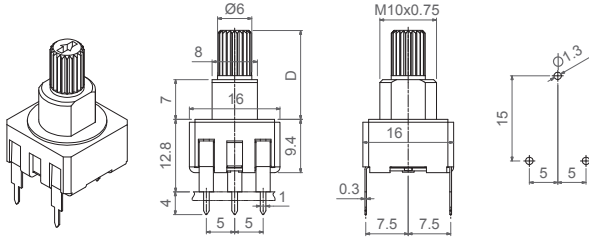

V17,5

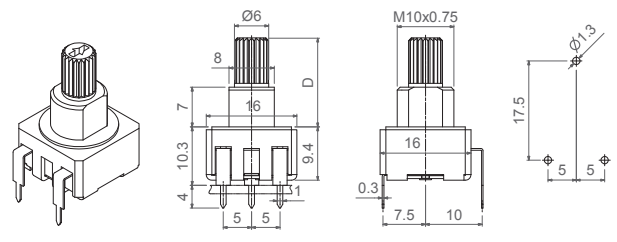

VD7,5

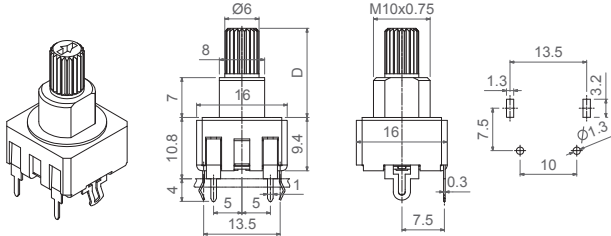

VD11

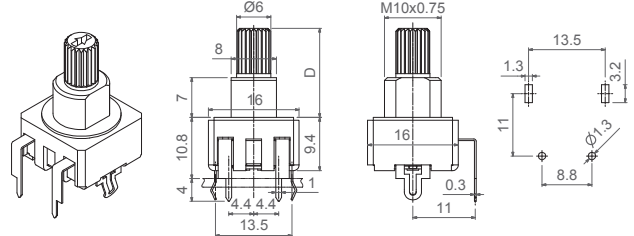

Nut

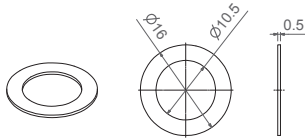

Washer

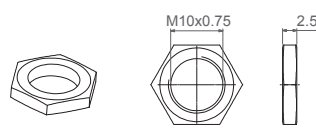

Nut and washer assembly indication

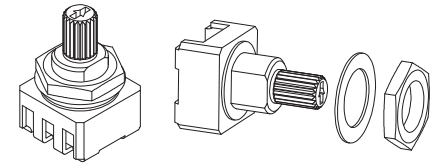

Tapers

The standard taper is linear (A). Log (B) and Antilog (C) tapers are also available, as well as special tapers according to customer's specifications. For example, a special taper can be matched with a potentiometer with detents (click effect), to guarantee a value in a specific position – see "detents" section. -

REGULAR TAPERS

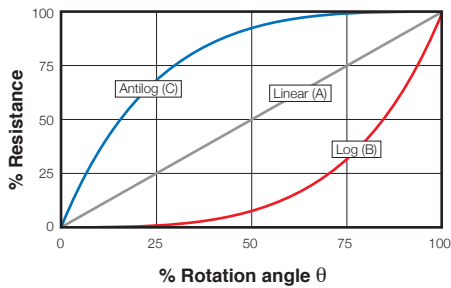

SPECIAL TAPERS

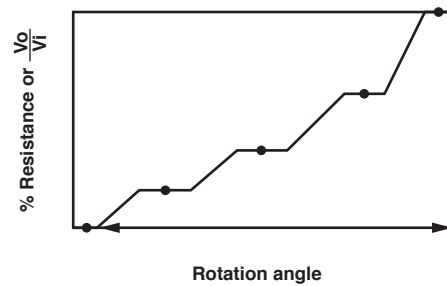

Potentiometers with cut track

The cut track is an area with very high resistive value, resulting in an open circuit. It is widely used in lighting applications.

Mechanical life with cut track needs to be confirmed.

PCI = Cut at initial position, when the potentiometer is turned fully counter clockwise.

PCF = Cut at final position, when the potentiometer is turned fully clockwise.

Other positions are available on request.

PCI

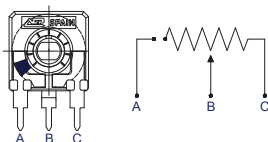

PCF

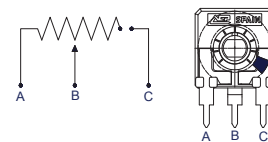

Potentiometers with detents

ACP's patented detent (DT) feature is especially suitable for control applications where the end user will turn a knob inserted in the potentiometer. Detents can be used to add a click feeling to the turning of the potentiometer or to control the position in which the wiper is placed, assuring a particular output value with a narrow tolerance.

Detents can be light or strong, or even a combination of different feelings. They can be evenly distributed along the angle (standard) or tailored to match customers' request. They can also be combined with special tapers: constant value areas, open circuit zone, different slopes, etc. One common example is a potentiometer with detents and matching non-overlapping voltage values in specific angular positions, used to feed in a voltage value to a microprocessor:

Example of 5DT with control of value in each DT.

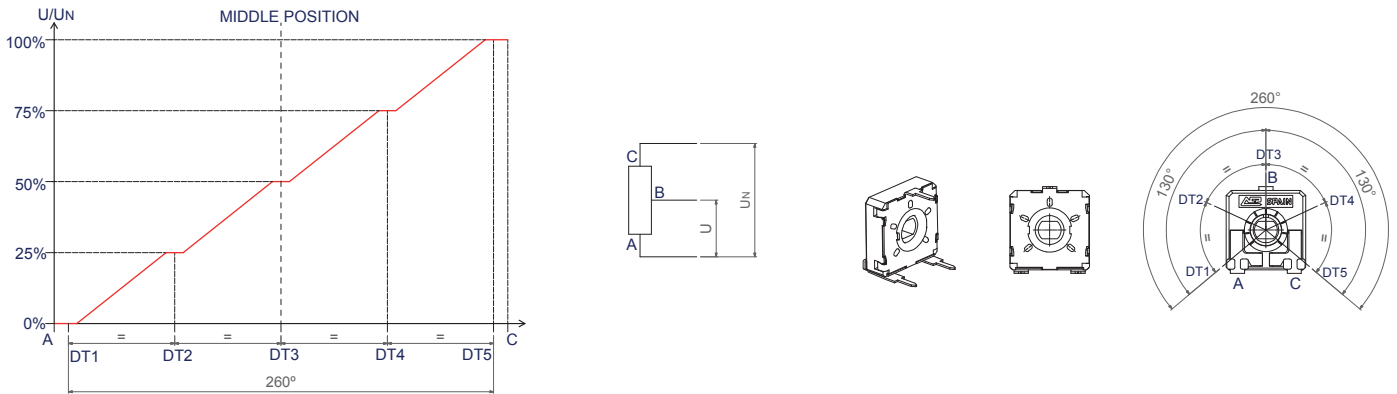

Examples of some potentiometers with detents:

14DT

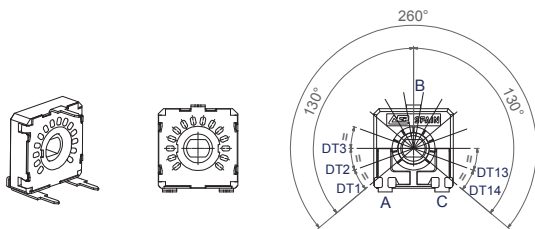

38DT

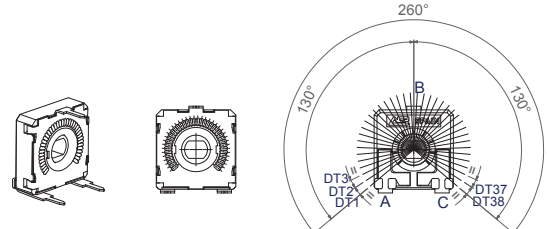

Number of standard detents (evenly distributed) already available.	1 (Initial, final or central), 3, 4, 5, 6, 7, 8, 9, 10, 13, 14, 17, 22, 27, 38.
Maximum number of detents for feeling only	38
Maximum number of detents when the voltage value in each detent is controlled and non-overlapping.	14

Our patented design with two wipers has improved the performance of these potentiometers, giving them more stable electrical parameters, improved reliability and Contact Resistance Variation (CRV) and narrower tolerances for detent positioning.

For potentiometers with detents, mechanical life is also 1.000 cycles if no additional cycles are mentioned. Up to 10.000 cycles are available. Please, indicate the number of cycles needed with LV (number of cycles), for example: LV10, for 10.000 cycles.

When needing a special number of detents or matching taper, a drawing is kindly requested.

Terminals

By default, terminals are always straight, as shown on the “models” section. ACP can provide crimped terminals (with snap in, “SNP” or “SNR”), to better hold the component to the PCB during the soldering operation.

SNP

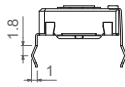

SNR

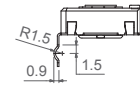

Also, there is an option of having shorter terminal tips:

Standard Terminal

Shorter terminal, for V12,5 TP30

Shorter terminal, TPXX (under request)

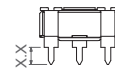
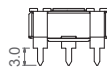
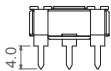

Adjustment and orientation

Should the shaft need to be positioned differently than shown on the “models” section on this catalogue, a drawing with the exact position is kindly requested.

Shafts

Shafts are available in different colors (color chart in “how to order” section) and with self-extinguishable property, according to UL 94 V-0, under request. ACP can study special shaft designs.

D dimension is the distance from the housing to the top of the shaft, as shown in the different models.

Shaft	14081	14187	14067	14008	14015	14066	14084	14250	14072	14073
D Dimension	15.2	15.7	24.7	20.2	20.2	20.45	20.45	21.95	28.7	35.45

14008

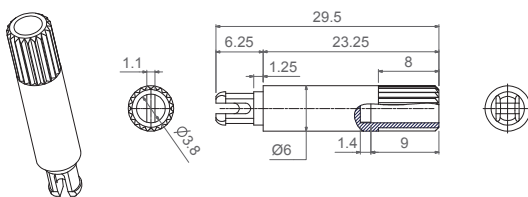

14015

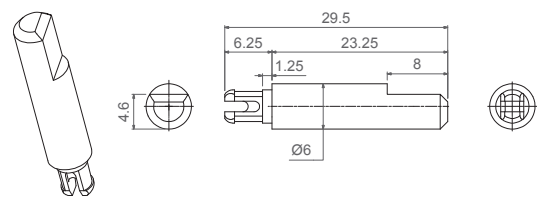

14066

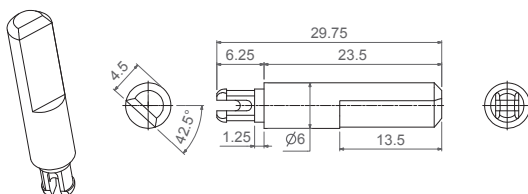

14067

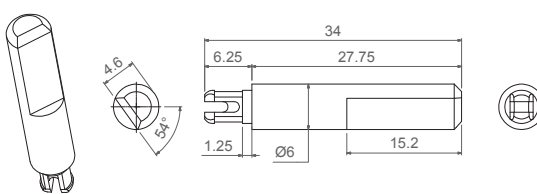

Shafts

14072

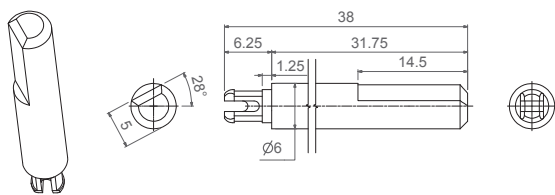

14073

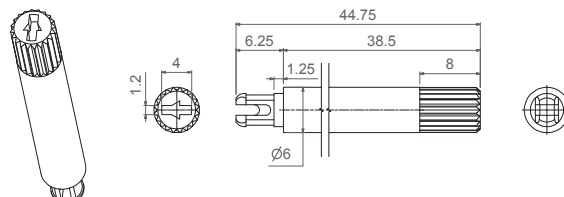

14081

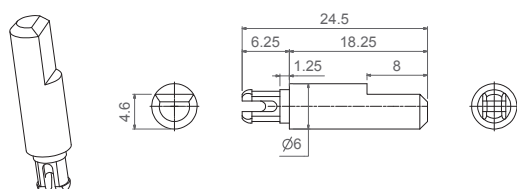

14084

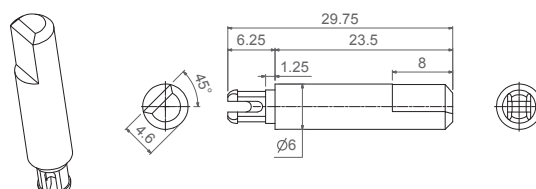

14187

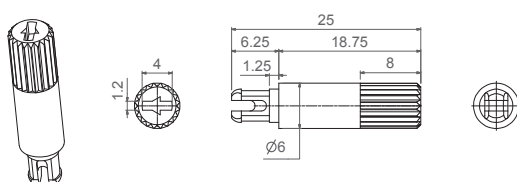

14250

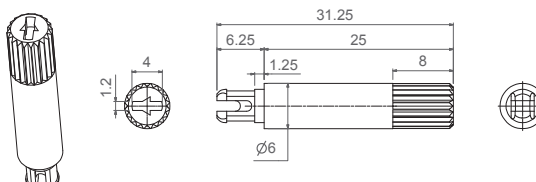

Packaging

Potentiometer model	With shaft or thumbwheel inserted?	Pieces per bigger box (250 x 150 x 70, CG on description)
H0 - HC0 - H2,5 - H4 - H5 - HA5 - HL5 V12,5 - V15 - VA12,5 - VL12,5 - VR12,5 VJ15 - V17,5 - VD11 - VD7,5	With any shaft.	150

Electric Specifications

These are standard features; other specifications and out of range values can be studied on request.

	MCA14 Through-hole	MCE14 Through-hole
Range of resistance values* Lin (A) Log (B) Antilog (C)	$100\Omega \leq R_n \leq 5M\Omega$ $1 K\Omega \leq R_n \leq 2M2\Omega$	$100\Omega \leq R_n \leq 5M\Omega$ $1 K\Omega \leq R_n \leq 2M2\Omega$
Tolerance* Rn < 100Ω: 100Ω ≤ Rn ≤ 100KΩ 100K < Rn ≤ 1MΩ: 1MΩ < Rn ≤ 5MΩ: Rn > 5MΩ:	+50%, -30% (out of range) ±20% ±20% ±30% +50%, -30% (out of range)	- ±20% ±20% ±30% -
Variation laws	Lin (A), Log (B), Antilog (C). Other tapers available on request	
Residual resistance	Lin (A), Log (B), Antilog (C) ≤ 5*10 ⁻³ *Rn. Minimum value 2Ω	≤2Ω
CRV - Contact Resistance Variation (dynamic)	Lin (A) Electrical Angle 245°±20° ≤ 3%Rn. Other tapers, please inquire	
CRV - Contact Resistance Variation (static)	Lin (A) Electrical Angle 245°±20° ≤ 5%Rn. Other tapers, please inquire	
Maximum power dissipation** Lin (A) Log (B), Antilog (C)	at 50°C 0.25W 0.13W	at 70°C. 0.7W 0.30W
Maximum voltage Lin (A) Log (B), Antilog (C)	250VDC 200VDC	
Operating temperature	-25°C ... +70°C (+85°C on request)	-40°C ... +90°C (+125°C on request)
Temperature coefficient 100Ω ≤ Rn ≤ 10KΩ 10KΩ < Rn ≤ 5MΩ	+200/ -300 ppm +200/ -500 ppm	±100 ppm ±100 ppm

* Out of range ohm values and tolerances are available on request, please, inquire.

** Dissipation of special tapers will vary, please, inquire.

Mechanical Specifications

	MCA14 Through-hole	MCE14 Through-hole
Resistive element	Carbon technology	Cermet
Angle of rotation (mechanical)	265° ± 5°	
Angle of rotation (electrical)	245° ± 20°	
Wiper standard delivery position	50% ± 15°	
Max. stop torque	10 Ncm	
Max. push/pull on rotor	50 N	
Wiper torque*	<2.5 Ncm Potentiometers with detents: <3.5 Ncm	
Mechanical life	1.000 cycles (many more available on request, please, inquire)	

* Stronger or softer torque feeling is available on request.

Test results

The following typical test results (with 95% confidence) are given at 23°C ±2°C and 50% ±25% RH.

	MCA14 Through-hole		MCE14 Through-hole	
	Test conditions	Typical variation of Rn	Test conditions	Typical variation of Rn
Damp heat	500 h. at 40°C and 95% RH	+5%, -2%	500 h. at 40°C and 95% RH	±2%
Thermal cycles	16 h at 85°C, plus 2 h at -25°C	±2.5%	16 h at 90°C, plus 2 h at -40°C	±2%
Load life	1.000 h. at 50°C	+0%; -5%	1.000 h. at 70°C	±2%
Mechanical life	1.000 cycles at 10 c.p.m. and at 23°C ± 2°C	±3%	1.000 cycles at 10 c.p.m. and at 23°C ± 2°C	±2%
Storage (3 years)	3 years at 23°C ± 2°C	±3%	3 years at 23°C ± 2°C	±1%

MCA14 Through-hole

MCE14 Through-hole

Power derating curve:

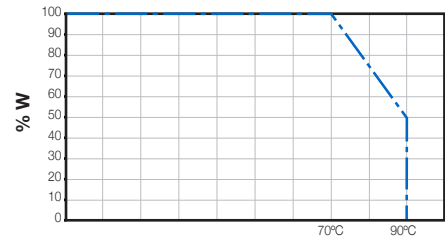
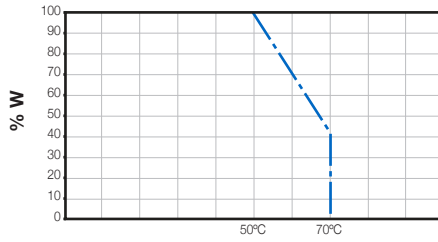

For temperatures out of range

The normal operation temperature for a carbon ACP potentiometer is -25°C to +70°C. When the temperature goes up to 85°C, the following variations should be observed:

Load life	1.000 h. at 50°C	+0%; -6%	1.000 h. at 85°C	+0%; -15%
-----------	------------------	----------	------------------	-----------

The power derating curve to consider is:

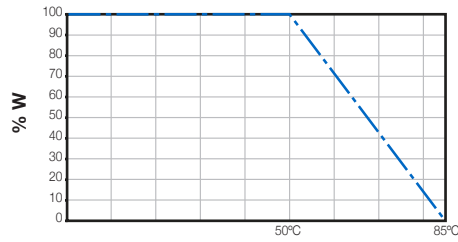

Representation of the typical variation of nominal resistance (with 95% confidence) throughout the ohm value range:

MCA14 Through-hole

MCE14 Through-hole

Damp heat

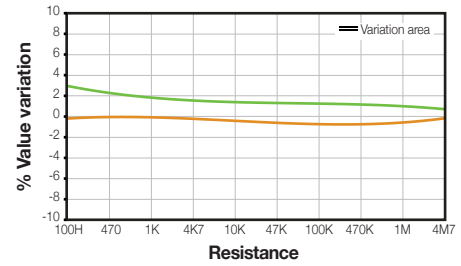
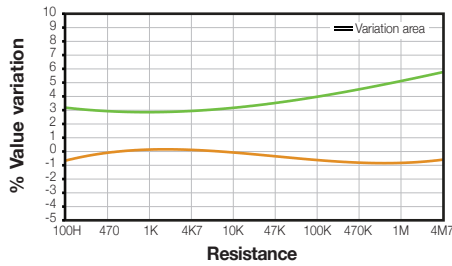

Temperature Coefficient

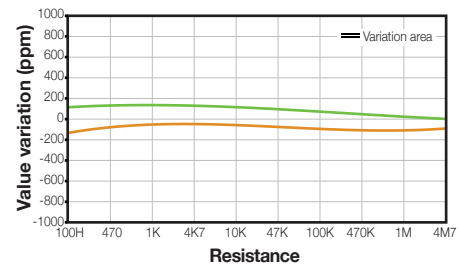
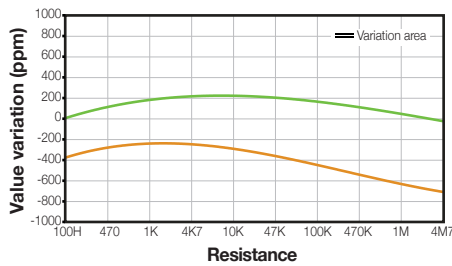

Load life

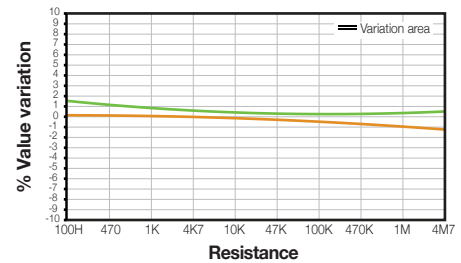
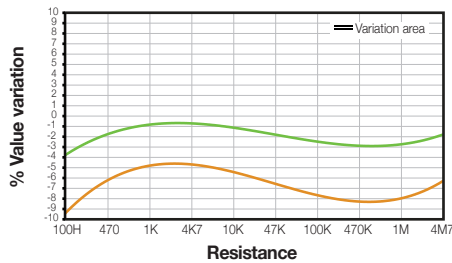

Mechanical life

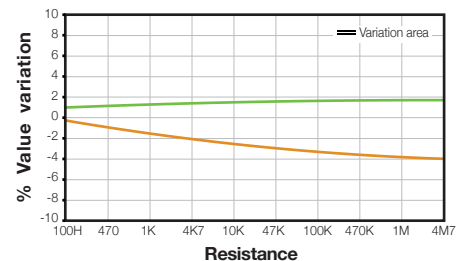
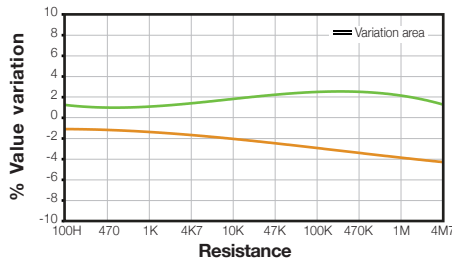

MCA14 MCE14